

**FOR INFORMATION ONLY:
DO NOT MANUFACTURE
PARTS TO THIS DRAWING**

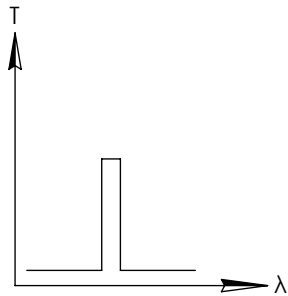
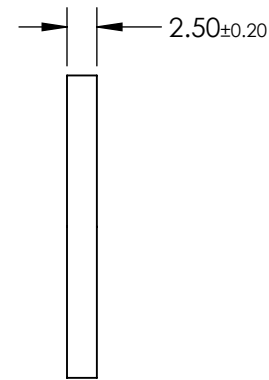
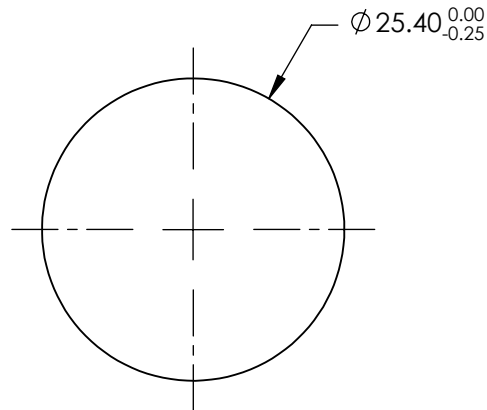
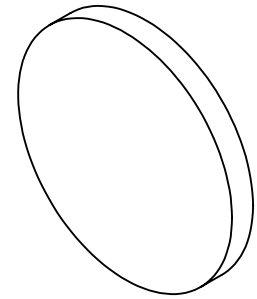

BANDPASS FILTER

SPECIFICATIONS SUBJECT TO CHANGE WITHOUT NOTICE
DIMENSIONS ARE FOR REFERENCE ONLY

	VALUE
SHAPE	PLANO
CENTER WAVELENGTH (nm)	330
FULL WIDTH HALF MAX (FWHM) (nm)	140
SURFACE QUALITY	60-40
COATING TYPE	Uncoated
BEVEL	PROTECTIVE AS NEEDED

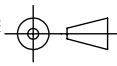
THIRD ANGLE PROJECTION 

ALL DIMS IN mm

 **Edmund Optics®**

TITLE HOYA U-330 (UV) 25.4mm Dia., Colored Glass Bandpass Filter

DWG NO 46437

SHEET 1 OF 1