

NOTES:

1. SUBSTRATE: B270
2. CONSTRUCTION: DICHROIC
3. SURFACE S2 TO BE PARALLEL TO SURFACE S1 TO WITHIN <3 arcmin

4. EDGE CUT

5. EXTINCTION RATIO: 100:1
6. OPERATING TEMPERATURE (°C) : -15 to +70
7. WAVELENGTH RANGE: 400 - 700nm
8. RoHS: COMPLIANT

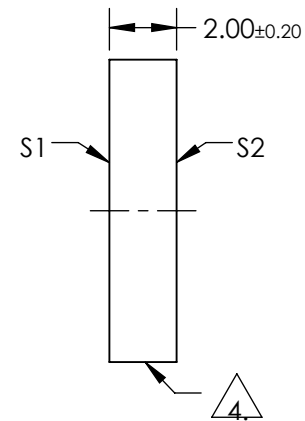
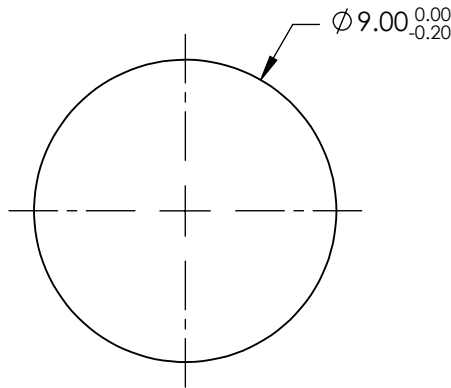
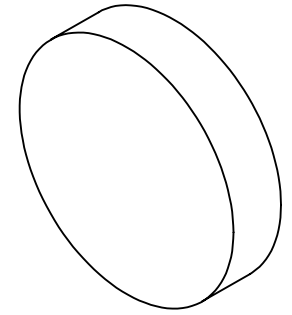

**FOR INFORMATION ONLY:
DO NOT MANUFACTURE
PARTS TO THIS DRAWING**

SPECIFICATIONS SUBJECT TO CHANGE WITHOUT NOTICE
DIMENSIONS ARE FOR REFERENCE ONLY

	S1 & S2
SHAPE	PLANO
SURFACE FLATNESS	4 - 6λ
SURFACE QUALITY	80-50
BEVEL	PROTECTIVE AS NEEDED

THIRD ANGLE
PROJECTION

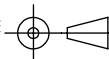

ALL DIMS IN

mm

EO® Edmund Optics®

TITLE

9mm DIA. Unmounted Linear Glass Polarizing
Filter

DWG NO

43783

SHEET
1 OF 1